



TECNOIDRO

doria holding



RICAMBI RIGENERATI

GRUPPI DI TRASMISSIONI MECCANICHE

ATTUATORI E GRUPPI COMANDO MARCE

CAMBI AUTOMATICI

CAMBI MECCANICI IVECO

CAMBI MERCEDES SCANIA VOLVO

CAMBI ZF

GRUPPI DI STERZO

PONTI E DIFFERENZIALI

RALLENTATORI

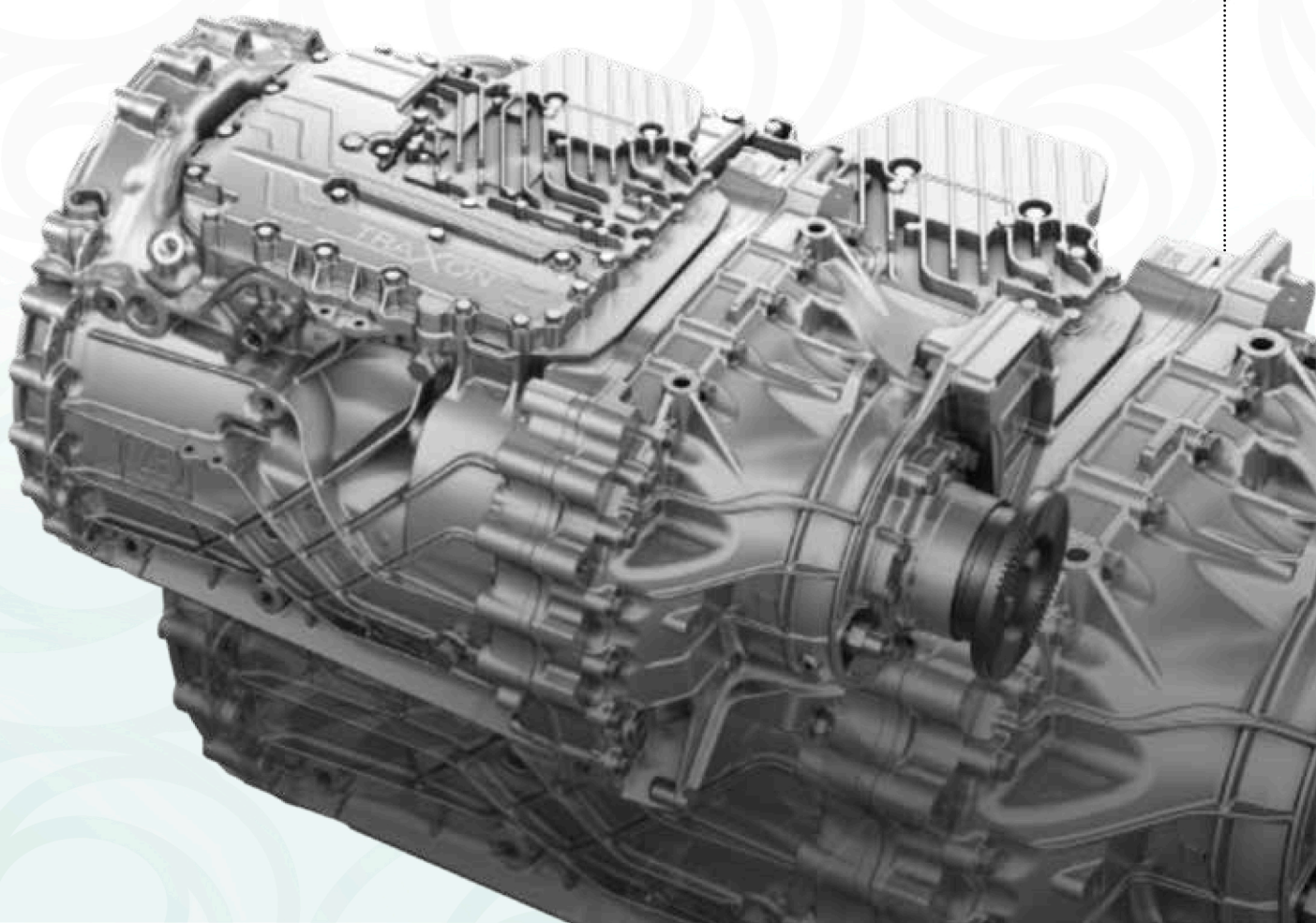

RICAMBI RIGENERATI: UNA SCELTA CONSAPEVOLE

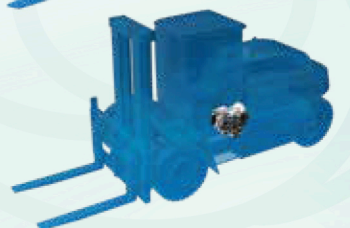
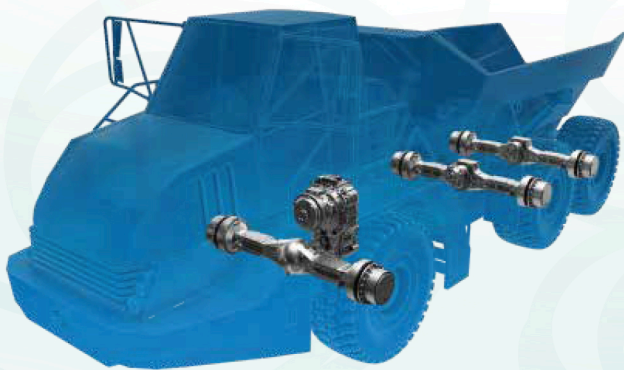
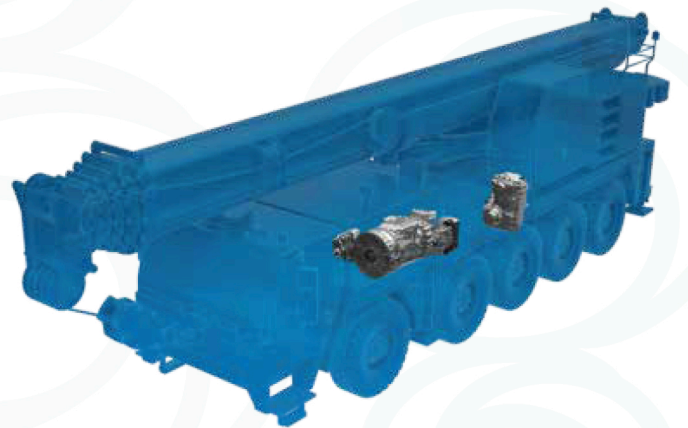
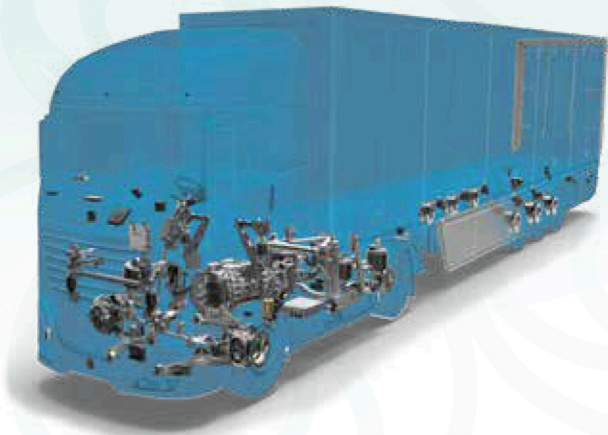

GRUPPI DI STERZO



GUIDA IDRAULICA



PISTONE PILOTA 2° ASSE



CILINDRO 3° ASSE



CILINDRO DI STERZO



POMPE DI STERZO

CAMBI MECCANICI

ZF

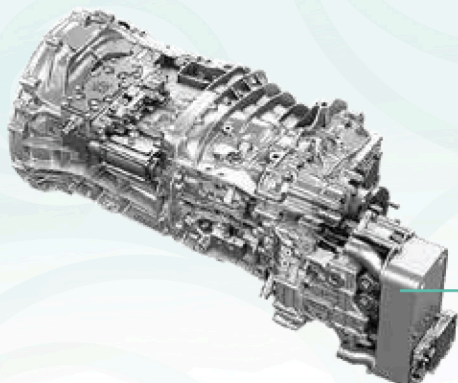

ZF ECOLITE

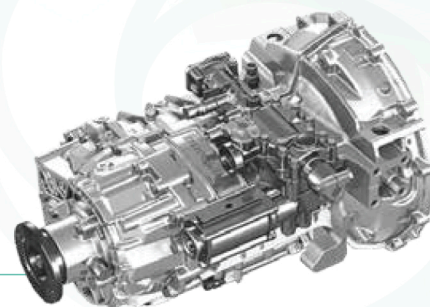

ZF ECOSPLIT

IVECO

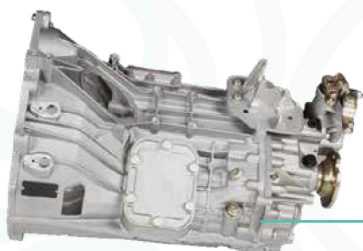

DAILY

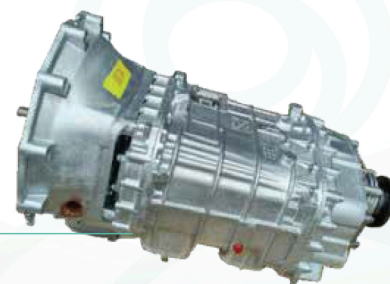

EURO CARGO

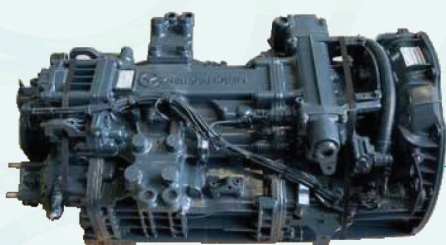

MERCEDES

CAMBI AUTOMATIZZATI

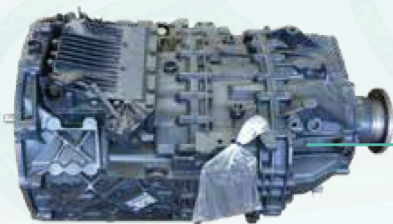

ZF ASTRONIC

MERCEDES

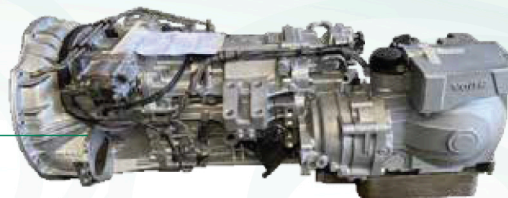

ATTUATORI



PARTE PNEUMATICA

COMPLETO



CAMBI AUTOMATICI

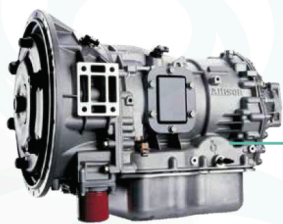

ZF ERGOPOWER WG

ALLISON

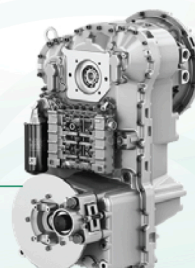

VOITH



ZF



MOTORI CV – TRUCK – BUS

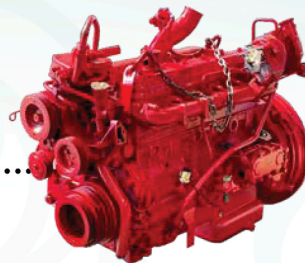

RALLENTATORI

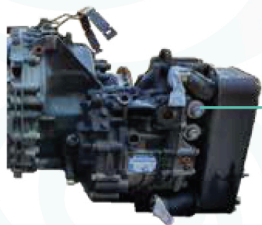

VOITH 115

ZF INTARDER

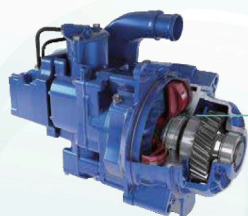

VOITH PRITARDER

VOITH AQUATARDER

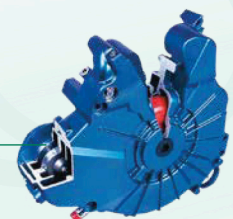

VOITH BUS

PONTI E DIFFERENZIALI



DIFFERENZIALE IVECO-DAILY-35C

MERITOR EUROCARGO

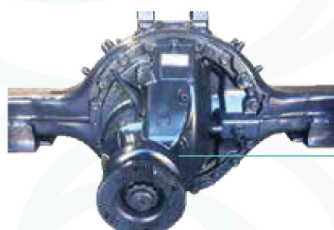

STRALIS

PONTE COMPLETO IVECO STRALIS



MERCEDES



ZF PONTE COMPLETO BUS

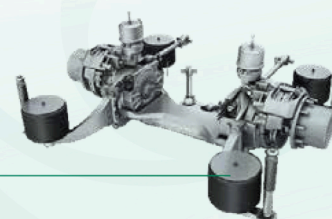

VEETTURE E COMMERCIALI



GUIDA ELETTRICA

GUIDA A CREMAGLIERA

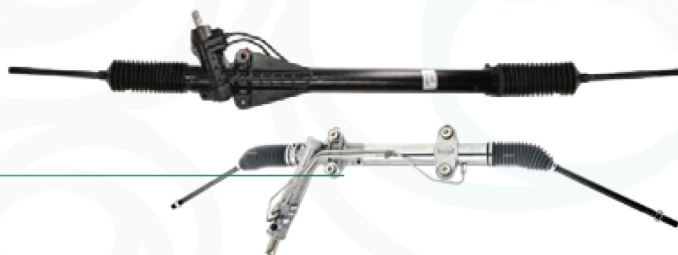

CAMBI AUTOMATICI

CAMBI ROBOTIZZATI

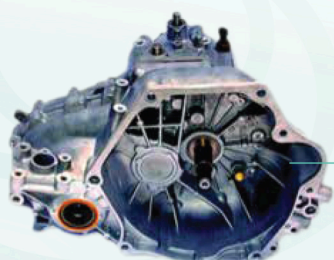
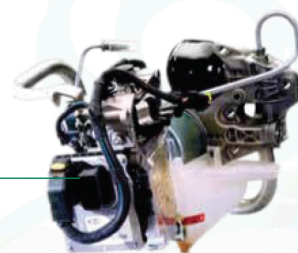

CAMBI MANUALI

VEETTURE E COMMERCIALI

CONVERTITORI DI COPPIA



RIPARTITORE DI COPPIA

DIFFERENZIALI

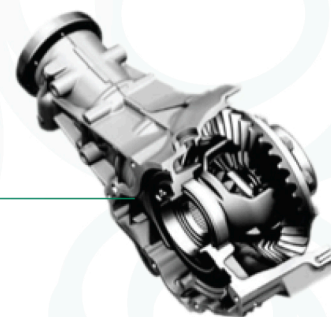

ALBERI DI TRASMISSIONE



doria holding

RICAMBI RIGENERATI

TECNOIDRO S.R.L.

Via Bellino, 79

88100 Catanzaro CZ Italy

ITALY

T +39 0961 719316

P.I.IT02769040797

info@tecnoidro.com

www.tecnoidro.com

CONTATTI

EMANUELE RODEGHIERO

Tel: +39 340 8979068

e-mail: emanuele.rodighiero@tecnoidro.com